

# KINCROME C

PROFESSIONAL QUALITY TOOLS

# AIR HYDRAULIC TRUCK JACK

## 22,000KG



**K12132**  
**22 Tonne**  
**ED3/SEP 19**



Caution: Do not allow persons to operate or assemble this jack until they have read this manual and developed a thorough understanding on how the jack works

**TABLE OF CONTENTS**

Know Your Product ..... 2  
 Important Safety Instructions ..... 3-4  
 Unpacking and Assembling Jack ..... 4-6  
 Air Hydraulic Jack Operation ..... 6-7  
 Air Hydraulic Jack Maintenance and Storage ..... 7  
 Troubleshooting ..... 8  
 Warranty ..... 8

**KNOW YOUR PRODUCT**

- 1. Release Knob
- 2. Handle Assembly
- 3. Lock Lever
- 4. Locking Rod
- 5. Air Hose
- 6. Wheels
- 7. Carry Handle
- 8. Bottle Jack
- 9. Saddle (Ø48x20mm)
- 10. Saddle (Ø48x60mm)
- 11. Saddle (Ø48x100mm)
- 12. Air Valve Assembly
- 13. Air Inlet

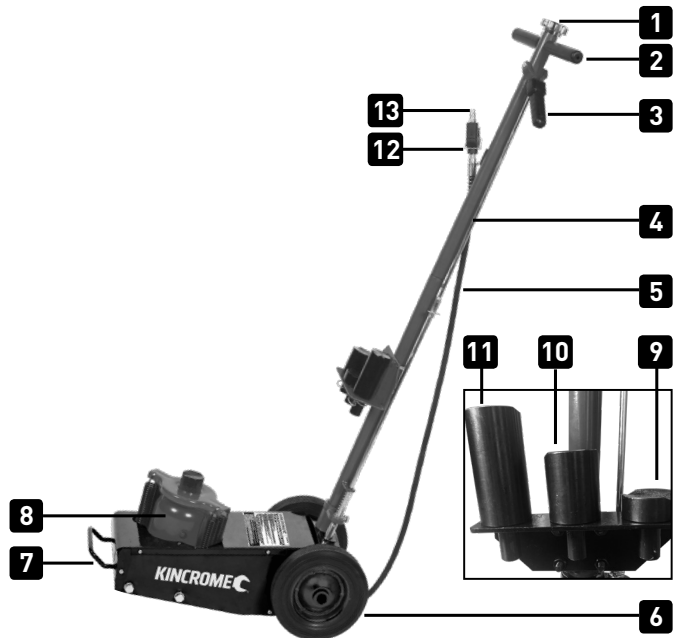

**SPECIFICATIONS**

Model No .....	K12132
Working Load Limit .....	22,000kg
Height Raised .....	452mm (without saddles)
Height Lowered .....	227mm
Head Cap Diameter .....	Ø45x20mm(9).....Ø48x60mm(10)..... Ø48x100mm(11)
Lift Height .....	122mm
Head Cap Screw Height.....	103mm
Operating Pressure .....	108-125PSI
Base Dimensions .....	250 x 186mm
Hose Length .....	1140mm
Air Fitting .....	1/4"
Approvals .....	meets the CE standard
Weight .....	34kg

## General Safety Warnings



Save all warnings and instructions for future reference.

**WARNING!** Read all safety warnings and all instructions. Failure to follow the warnings and instructions may result in serious injury or death.

## IMPORTANT SAFETY INFORMATION

The use of a vehicle jack has inherent dangers. To avoid risk of personal injury or property damage, make sure you are fully aware of the operating instructions for this product, the recommendations in the vehicle owners manual for jacking of your vehicle, prior to lifting the vehicle. Do not exceed maximum lifting capacity of this jack. This jack is intended for automotive use only. Be aware that large or heavy vehicles may exceed jack's stated capacity check vehicle owners manual or contact the vehicle manufacturer. Do not use for any other purpose except the raising and lower of vehicles, Never use to raise any structure or building, Do not lift any human load and never ride on jack.

### Preparing Work Area







Before using jack to lift vehicle, it is important to prepare work area properly. Follow this procedure each time the jack is used to help prevent property damage and or serious injury.

1. **Thoroughly inspect jack for damage or wear before each use.** Briefly test operation of unloaded jack before using to lift any load. If jack is damaged or is malfunctioning DO NOT LIFT ANY LOAD until the problem is corrected.
2. **The Vehicle manufacturer's owner's manual should be consulted prior to the lifting of the vehicle.** It will advise safety precautions, jacking procedure, vehicle weight, recommended jack type, and location of jack support areas on vehicle. NEVER EXCEED WORKING LOAD LIMIT OF JACK.
3. **Clear children and others from work area before moving or lifting vehicle.** Another adult should be nearby for extra safety and assistance but must be clear of vehicle as it is moved or lifted. No person should remain in a vehicle that is being jacked. No person should enter a vehicle which is supported by a jack or by vehicle support stands. No person should lean into a vehicle which is supported by a jack or by vehicle support stands.
4. **No person should place any portion of their body under a vehicle that is supported by a jack.**
5. **Clear obstructions from work area.** Working in tight or cluttered work areas is dangerous.
6. **The hydraulic vehicle jack should be used for lifting and lowering only;** the raised vehicle should be supported on vehicle support stands.
7. **Be sure jack and vehicle are on solid, level ground such as paved or concrete driveway or garage floor.** The jack should be used on level firm ground wherever possible. Uneven or sloped surfaces create hazardous working conditions and dangerously impeded the function of the jack.
8. **With vehicle in proper position, set vehicle's parking brake or emergency brake and put gear-shift in park (manual transmissions should be placed in lowest gear).** TURN VEHICLE IGNITION OFF AND TO THE "LOCK" POSITION making sure steering wheel locks.
9. **It is recommended that the wheels of the vehicle be chocked.** Do not rely on vehicle transmission or brakes to hold vehicle in position. Chock all wheels of vehicle not being lifted off the ground to prevent vehicle rolling. Using wedge-shaped blocks that tyre cannot roll over, position one chock tight against the tyre in both forward and reverse rolling paths.
10. **The load should be centrally located on the head cap.** Off centre loads can be unstable.
11. **The hydraulic vehicle jack should be used for lifting and lowering only;** the raised vehicle should be supported on vehicle support stands. Vehicle support stands (not included) will be needed to support vehicle once it is in raised position. Have jack stands, vehicle support stands capable of supporting vehicle weight ready nearby for use. Read and understand jack stand manufacturer's instructions and safety information before use and before lifting the vehicle with this jack.
12. **Plan location of jack beneath vehicle, making sure jack will be contacting only a jack support area of vehicle.** Consult vehicle owner's manual for location of jack support areas.

## Personal Safety

1. **Stay alert.** Watch what you are doing and use common sense when operating the tool. Do not use the tool while tired or under the influence of drugs, alcohol, or medication. A moment of inattention while operating the tool, increases the risk of injury to persons.
2. **Dress properly. Do not wear loose clothing or jewellery. Contain long hair. Keep hair, clothing, and gloves away from moving parts.** Loose clothes, jewellery, or long hair increases the risk of injury to persons as a result of being caught in moving parts.
3. **Avoid unintentional starting.** Be sure the switch is off before connecting to the air supply. Do not carry the tool while touching the switch or connect the tool to the air supply with the switch on.
4. **Do not overreach. Keep proper footing and balance at all times.** Proper footing and balance enables better control of the tool in unexpected situations.
5. **Use safety equipment.** A dust mask, non-skid safety shoes and a hard hat must be used for the applicable conditions.
6. **Always wear eye protection.** Wear ANSI-approved safety goggles.
7. **Always wear hearing protection when using the tool.** Prolonged exposure to high intensity noise is able to cause hearing loss.
8. **The warnings, cautions and instructions discussed in this manual can not cover all possible conditions and situations that may occur.** It must be understood by the operator that common sense and cautions are factors which can not be built into this product, but must be supplied by the operator.
9. **Keep Children away.** Children must never be allowed in the work area. Do not let them handle tools, machines or air lines.
10. **Use the right tool for the job.** Do not attempt to force a small tool or attachment to do the work of a larger industrial tool, Do not use a tool for a purpose it was not intended.

## Descriptions Of Symbols

Symbol	Property or statement		
			WARNING marking concerning Risk of Eye Injury. Wear ANSI-approved eye protection.
psi	Pounds per square inch of pressure		Risk of Hearing Loss. Wear hearing protection.
cFM	Cubic Feet per Minute flow		WARNING marking concerning Risk of Respiratory Injury. Wear NIOSH-approved dust mask/respirator.
ScFM	Cubic Feet per Minute flow at standard conditions		WARNING marking concerning Risk of Explosion.
	Read the instructions before using the machine		Marking concerning Risk of Injury.

## UNPACKING & ASSEMBLING JACK

Unpack all the components from the box.

When unpacking the Air/Hydraulic Truck Jack, carefully inspect for any damage that may have occurred during transit.

Check for loose, missing or damaged parts.

1. Ensure all packaging materials are disposed of as per your local council guide lines.

## Assembly

1. Remove the bolt on upper handle tube, then insert the upper handle tube into the lower handle tube, screw on the bolt and tighten it. (Fig. 1, Fig. 2)
2. Remove the R pin and nut on the locking rod (4), insert the locking rod (4) through the handle yoke guide on the lower handle tube, then screw on the nut. (Fig. 3)
3. Connect the locking rod (4) with the thread on upper handle tube and tighten the nut. (Fig. 4)
4. Put the R pin back on the locking rod (4). (Fig. 5)
5. Remove the bolt under the handle yoke. (Fig. 6)
6. Insert the lower handle tube in the handle yoke while simultaneously inserting the locking rod (4) in the handle yoke guide holes. (Fig. 7)
7. Raise the lock lever (3) on the handle assembly (2) up so the locking rod (4) does not have to come in contact with the handle yoke.
8. Rotate the release knob (1) at the top of the handle assembly (2) back and forth until the bottom of the handle assembly (2) engages the release knob (1) cable inside and at the bottom of the handle yoke. (Fig. 8)
9. Move the handle assembly (2) up and down while simultaneously pushing down the lock lever (3) until the locking rod (4) engages one of the locating holes in the handle yoke bracket. There are three holes in the handle yoke bracket that are used to lock the handle assembly (2) in either a horizontal, angular or almost vertical position. (Fig. 9)
10. The air valve assembly (12) and air hose (5) are equipped with a loop that secures them to the "L" shaped hook on the upper portion of the handle (Fig. 10).
11. Secure the air valve assembly (12) and air hose (5) to the handle assembly (2) and connect a shop air line to the air valve assembly (12) (Fig.10).
12. Sometimes air gets trapped in the hydraulic system during shipment. An air bound hydraulic system feels spongy when pumped. Follow the instructions below to purge your hydraulic system.

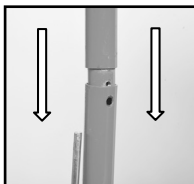

Fig.1

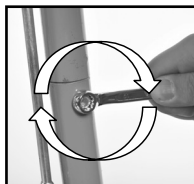

Fig.2

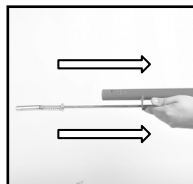

Fig.3

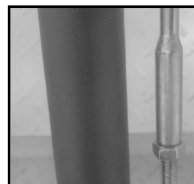

Fig.4

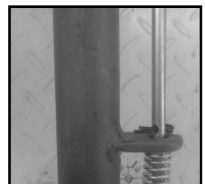

Fig.5

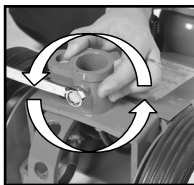

Fig.6

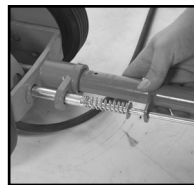

Fig.7

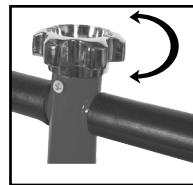

Fig.8

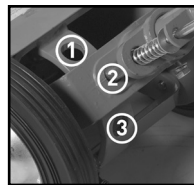

Fig.9



Fig.10

## Assembling the Saddle holder

1. Carefully place the saddle holder onto the handle assembly (2).
2. Feed the U bolts over the handle assembly (2) and feed through the mounting holes of the saddles on board storage.
3. Fasten with the washers and nuts supplied.
4. Insert the saddles through the holder hole and secure in place with the cotter pins (Fig 11).



Fig. 11

## Purging Air from the Hydraulic System

**Note:** Before first use, the hydraulic system may need to be purged. Some air may intrude in the hydraulic system caused by movement during shipping. Air bubbles can become trapped inside the hydraulic system, thereby reducing the efficiency of the Jack.

Purge air from the system if efficiency drops.

- Open the release valve by turning the release knob (1) in a counter-clockwise direction two full turns from the closed position.
- Depress the lever on the air valve assembly (12) for approximately 30 seconds.
- Close the release valve by turning the release knob (1) in a clockwise direction until tight.
- Depress the lever on air valve assembly (12) until the ram raises to maximum height.
- If the condition remains, repeat steps "a" through "d" until all the air is purged from the system.

## AIR HYDRAULIC JACK OPERATION

- Park vehicle on a flat, level, solid, surface safely away from oncoming traffic. Turn off the vehicle's engine.
- Place the vehicle's transmission in "PARK" (if automatic) or in its lowest gear (if manual).  
Set the vehicle's emergency brake.
- Then, chock the wheels that are not being lifted.

**Caution:** If an automatic oiler system is not used, add 3-4 drops of Kinchrome Air Tool Oil to the air inlet (14) before operation. Add 1-2 more drops every hour of continual use.

## Raising the Ram Plunger



**WARNING!** Do not overload this jack. Maximum capacity, refer to the specification section for the max working limits.

- Select the desired saddle (9,10 or 11) and place into the bottle jack.
- Position the handle assembly (2) in desired angle. This is done by pulling the lock lever (3) (fig.12) and raising or lowering the handle to one of the three pre-set position (fig.13). Release the lock lever (3) to lock the handle in the desired position.
- Turn the release knob (1) completely clockwise to its closed position. Then connect to the air supplies air hose (not included) to the air inlet (13).
- Depress the lever on the air valve assembly (12) until the Saddle (9,10 or 11) of the Air/Hydraulic Truck Jack has nearly reached the vehicle lifting point. Position the Jack at 90° to the vehicle's lifting point to ensure the Jack's Saddle and vehicle lifting point are in alignment. If not, remove and then reposition the Air/Hydraulic Truck Jack before lifting.
- To lift the vehicle, continue to depress the lever on the air valve assembly (12) (fig 14).
- Adjust jack stands (not included) to the same minimum practical height according to the manufacturer's instructions.
- Position the jack stand (not included) under the vehicle manufacturer's recommended support points.



**WARNING!** Ensure that the vehicle support points are fully seated in the saddles of both jack stands. Always use jacks stands in pairs to support a vehicle one end only.

- Slowly turn the release knob (1) counter-clockwise to lower the vehicle onto the jack stands (Fig 15).

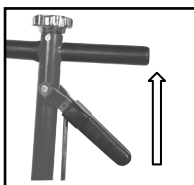

Fig. 12

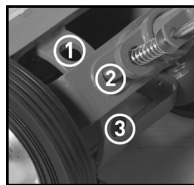

Fig. 13

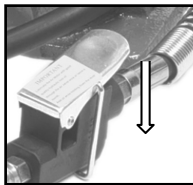

Fig. 14

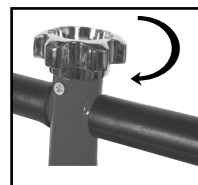

Fig. 15

### Lowering the Ram Plunger

**Caution:** Make certain that all personnel are clear of the load before lowering. Control the rate of descent of the load at all times. The more you rotate the release knob (1), the faster the load descends.

1. Raise load high enough to clear the jack stands (not included), then carefully remove jack stands (always used in pairs).
2. Slowly turn the release knob (1) counter-clockwise, but no more than 1 full turn. If the load fails to lower:
  - a) Use another jack to raise the vehicle high enough to reinstall jack stands.
  - b) Remove the affected jack and then the stands.
  - c) Lower the load by turning the release knob (1) counter-clockwise, but no more than 1 full turn.
3. After removing jack from under the load, push ram and handle sleeve down to reduce exposure to rust and contamination.

## AIR HYDRAULIC JACK MAINTENANCE & STORAGE

**Caution:** Prior to making any adjustments ensure the compressor is turned off and unplugged, and the air hose (5) are stationary.

**Note:** These procedures are in addition to the regular checks and maintenance explained as part of the regular operation of the air-operated tool.

1. **BEFORE EACH USE**, inspect the general condition of the tool. Check for:
  - a) loose hardware or housing,
  - b) misalignment or binding of moving parts,
  - c) cracked or broken parts, and
  - d) any other condition that may affect its safe operation.
2. **Daily - Air Supply Maintenance:**
  - a) Every day, maintain the air supply according to the component manufacturers' instructions. Drain the moisture filter regularly.
  - b) Performing routine air supply maintenance will allow the tool to operate more safely and will also reduce wear on the tool.
3. **Quarterly (every 3 months) – Tool Disassembly, Cleaning, and Inspection:** Have the internal mechanism cleaned, inspected, and lubricated by a qualified technician.
4. Periodically check the air and hydraulic fittings for leaks. Repair if any leak is detected.
5. Periodically lubricate all moving points of the Jack.
6. The Hydraulic Ram should be kept clean, free of dirt and water, and protected from corrosion.
7. **Oil Replacement:**
  - a) Place Jack in an upright position.
  - b) Completely lower the Ram.
  - c) Remove the Oil Filler Plug (Fig 16) and keep it clean.
  - d) Fill Reservoir with Kinchrome hydraulic jack oil, (K12400) to the lower rim of the oil fill hole.
  - e) Purge air from the hydraulic system as previously described on PURGING AIR FROM THE HYDRAULIC SYSTEM on page 6.
  - f) Top off with more hydraulic oil.
  - g) Replace Oil Filler Plug.

### Repairing Jack/Spare Parts

There are no user serviceable parts except as outlined above. Only trained, licensed and certified repair personnel should attempt any repairs or replacing of parts. Any modifications to this jack, except those performed by the manufacturer, or their designee, will void all warranties both written and implied.

### Caring for the Environment



When a tool is no longer usable it should not be disposed of with household waste, but in an environmentally friendly way. Please recycle where facilities exist. Check with your local council authority for recycling advice.



Recycling packaging reduces the need for landfill and raw materials. Reuse of recycled material decreases pollution in the environment. Please recycle packaging where facilities exist. Check with your local council authority for recycling advice.

## TROUBLESHOOTING

Symptom	Cause	Remedy
Jack will not lift load.	<ol style="list-style-type: none"> <li>1. Release Knob (1) not fully closed.</li> <li>2. Oil level low.</li> <li>3. Air supply low.</li> </ol>	<ol style="list-style-type: none"> <li>1. Close Release Knob (1) firmly.</li> <li>2. Top-up to correct level.</li> <li>3. Adjust the compressors air pressure between 108psi to 125psi</li> </ol>
Jack will not hold load.	<ol style="list-style-type: none"> <li>1. Release Knob (1) not fully closed.</li> <li>2. Overload condition</li> <li>3. Hydraulic unit malfunction</li> </ol>	<ol style="list-style-type: none"> <li>1. Close Release Knob (1) firmly.</li> <li>2. Remedy overload condition</li> <li>3. Contact Kincrome customer Service</li> </ol>
Jack will not lift smoothly or to full height.	<ol style="list-style-type: none"> <li>1. Oil level low.</li> <li>2. Air in hydraulic system.</li> </ol>	<ol style="list-style-type: none"> <li>1. Top-up to correct level.</li> <li>2. Bleed system - Purging Air From Hydraulic System (Page 6)</li> </ol>
Jack will not lower completely.	<ol style="list-style-type: none"> <li>1. Release Knob (1) not sufficiently open.</li> <li>2. Reservoir overfilled</li> </ol>	<ol style="list-style-type: none"> <li>1. Slowly open valve further.</li> <li>2. Check oil level</li> </ol>

### Office Contact Details:



Phone: 1300 657 528



Fax: 1300 556 005



Email: [enquiries@kincrome.com.au](mailto:enquiries@kincrome.com.au)



Website: [www.kincrome.com.au](http://www.kincrome.com.au)

## WARRANTY



Warranty given by Kincrome Australia Pty Ltd of 3 Lakeview Drive, Caribbean Park, Scoresby, Victoria (Tel +61 3 9730 7100). The applicable warranty period (2 years) commences on the date that the product is purchased. If this product has materials or workmanship defects (other than defects caused by abnormal or non warranted use) you can, at your cost, send the product to place of purchase, an authorised Kincrome service agent or one of Kincromes addresses for repair or replacement. Your rights under this warranty are in addition to any other rights you have under the Australian Consumer Law or other applicable laws. Our goods come with guarantees that cannot be excluded under the Australian Consumer Law. You are entitled to a replacement or refund for a major failure and compensation for any other reasonably foreseeable loss or damage. You are also entitled to have the goods repaired or replaced if the goods fail to be of acceptable quality and the failure does not amount to a major failure. For further details please visit [www.kincrome.com.au](http://www.kincrome.com.au) or call us. Due to minor changes in design or manufacture, the product you purchase may sometimes differ from the one shown on the packaging.

Distributed by Kincrome Tools and Equipment [www.kincrome.com.au](http://www.kincrome.com.au) 3 Lakeview Drive Scoresby Victoria Phone: +61 3 9730 7100